



Jean-Pierre Thierry

Engineering graduate from the CESI (Centre d'Etudes Supérieures Industrielles) and from the CNAM (Conservatoire National des Arts et Métiers), he was initially employed in the Iron and Steel industry (roll mill automation and fluid monitoring).

Following several years dedicated to preparing and developing mechanical vibration testing means, he joined Telemecanique in 1969. He then held in turn the positions of engineering and design department manager and technical Project manager for new products. He is currently in charge of developing prefabricated electric ducts.



Christophe Kilindjian

After graduating as an engineer from the Ecole Supérieure d'Energie et des Matériaux of Orléans in 1986, he then joined Merlin Gerin in this same year as part of the Technical Section in the Low Voltage Switchboards unit. Responsible for basic studies, he specialises in problems of heat exchanges and electrodynamic withstand in LV equipment.

n° 162

electrodynamic
forces on
busbars in
LV systems

electrodynamic forces on busbars in LV systems

contents

1. Introduction		p. 4
2. Electrodynamic forces between two conductors: origin and calculations	Preliminary remarks	p. 4
	Origin and calculation methods	p. 4
	Calculation for two parallel filiform conductors of infinite length	p. 6
	Influence of conductor shape	p. 6
	Conductors of reduced length	p. 7
	Non-rectilinear conductors	p. 7
	Calculation in the case of complex configurations	p. 7
3. Electrodynamic forces in a three-phase busbar on a two or three-phase fault	Reminder on short-circuit current making	p. 9
	Maximum force on a three-phase busbar	p. 10
	Resonance phenomena	p. 11
4. Application to LV three-phase busbars	Case of busbars in LV switchboards	p. 12
	Case of prefabricated ducts of the Canalis and Victa Dis type	p. 16
5. Conclusion		p. 20
6. Bibliography		p. 20

The importance attached to the concept of industrial dependability (safety of persons and equipment, availability of electrical power, reliability and maintainability of products) increasingly affects the design of the electrical devices used in industry (process...) and tertiary (hospitals). Their operating dependability thus contributes, often to a large context, to the dependability of the installation as a whole. This is the case of low voltage (LV) switchboards and of prefabricated transformer-switchboard connections.

This quest for dependability requires studies in order to master, from the design stage, the behaviour of their components in the light of their environment and of possible operating stresses. One of these studies has already been dealt with in a «Cahier Technique» (thermal behaviour of LV electric switchboards). Withstand of electrodynamic forces is now the subject of a second study.

Designers will find in this «Cahier Technique» the calculations laid down to allow for these forces and in particular to determine LV busbar requirements (prefabricated in ducts for electrical power distribution, and in switchboards).

However calculation alone is not sufficient and results need to be validated by a real-life tests. We thus briefly describe the standardised tests.

1. introduction

The problem of withstanding electrodynamic forces arises on the LV power circuits of the installation. Although mainly dependent on the strength of the fault current, it also depends on the shape of the conductors, their mutual setout and securing method. Although this problem can be solved by calculation, only validation by a real-life tests enables provision of a document acknowledging conformity with standard and/or customer requirements.

The very high current strengths that may occur during a short-circuit

between the various conductors of a LV installation (solid conductors of the bar, cable type...) generate considerable forces (several thousands of daNm). These forces thus need to be determined in order to mechanically size both the conductors and the structures supporting them so that they can withstand these forces whatever protective devices are placed upstream and downstream (standards stipulate electrodynamic withstand tests of one second).

The exact calculation of electrodynamic forces is often complex in view of the

geometry of the conductors and associated structures.

However a few approximations yield in most cases valid results on the basis of simple formulae.

After a brief reminder of calculation of electrodynamic forces in simple geometries, this Cahier will deal with busbars in switchboards and prefabricated ducts on the basis of these formulae.

2. electrodynamic forces between two conductors: origin and calculations

The problem of conductor withstand to electrodynamic stresses is certainly not new as is shown by the number of publications which have treated this issue. However this problem is still of interest to designers as a result of the application of modern numerical methods which provide a solution for complex conductor configurations. This accounts for the summary presented in this chapter.

preliminary remarks

Application of the formulae call for compliance with the following points:

- all the formulae involve the product of the current strengths, I_1, I_2 , flowing in each conductor and inter-reacting. If their values are identical, this product is replaced by the term I^2 .

- the current strengths appearing in the formulae correspond to the peak value of the currents conveyed in each conductor.

However the root mean square values I_{rms} are used in most cases; in this case I_{rms} must be multiplied by a coefficient defined in chapter 3.

- forces are expressed in absolute value without specifying their direction depending on field and current direction.

In most cases they are forces per unit of length.

- conductors are made of non-magnetic material and are sufficiently distant from all magnetic elements likely to alter distribution of the magnetic field that they create.

- skin effect and proximity phenomena which can considerably alter current distribution in the cross-section of solid conductors are ignored.

origin and calculation methods

The highlighting and understanding a century ago of mutual influences,

whether between two current elements or between a magnetic field and an electric current (work conducted by Oersted, Ampère...) resulted in the construction of a theoretical framework integrating these dynamic phenomena between conductors through which electric current flows.

The direction of the electrodynamic forces is known (repulsion if the currents in the conductors flow in opposite directions, otherwise attraction) and their values are obtained by applying the laws of magnetism.

There are in fact two main methods for calculating electrodynamic forces. The first method consists of calculating the magnetic field created by an electric current at a point in space, then deducing from it the resulting force exerted on a conductor placed at this point and through which

an electric current flows (possibly different from the first one).

To calculate the field it uses (see box, fig. 1) either Biot and Savart's law:

$$(1) \vec{dB} = \frac{\mu_0}{4\pi} i \frac{d\vec{\ell} \wedge \vec{u}}{r^2},$$

or Ampère's theorem:

$$\oint_c \vec{B} \cdot d\vec{\ell} = \mu_0 I,$$

and to calculate electrodynamic force, it uses Laplace's law:

$$(3) d\vec{f} = i d\vec{\ell} \wedge \vec{B}.$$

The second method is based on calculating the potential energy variation of a circuit and uses Maxwell's theorem :

$$(4) F_x = i \frac{\delta\Phi}{\delta x}$$

(see box, figure 1).

Biot and Savart's law

Each element of a circuit through which a current i flows, of a length $d\vec{\ell}$, produces at a point M a field $d\vec{B}$ such that:

$$d\vec{B} = \frac{\mu_0}{4\pi} i \frac{d\vec{\ell} \wedge \vec{u}}{r^2}.$$

This field is:

- perpendicular to the plane defined by the element $d\vec{\ell}$ containing point P and point M,

- oriented to the left of an observer placed on the element, with the current flowing from his feet to his head and his gaze directed to point M (Ampère's theorem)

- modulus $|d\vec{B}|$ where \vec{u} is the directing vector of \vec{PM} .

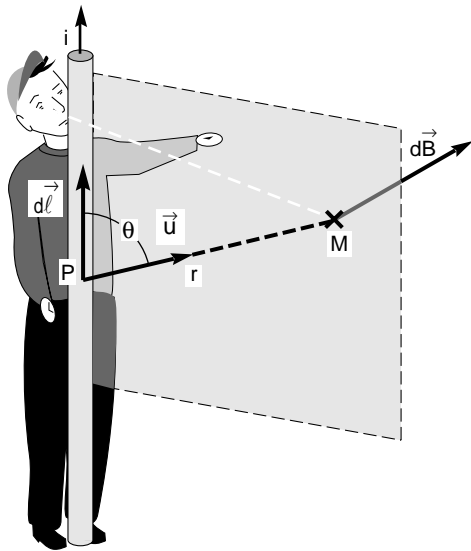

Ampère's theorem

Deduced from Biot and Savart's formula, it is expressed as follows:

Let I be the current strength flowing through a conductor crossing any surface of contour C .

Circulation of the magnetic field along C is given by the equation:

$$\oint_c \vec{B} \cdot d\vec{\ell} = \mu_0 I.$$

Laplace's law

When a circuit through which a current of strength i flows, is placed in a magnetic field \vec{B} , each element $d\vec{\ell}$ of the circuit is subjected to a force equal to:

$$d\vec{f} = i d\vec{\ell} \wedge \vec{B}$$

When \vec{B} has an electric circuit as its origin, the law applied to each one expresses the force exerted between them:

$$d\vec{f} = i_1 d\vec{\ell} \wedge \vec{B}_2 = i_2 d\vec{\ell} \wedge \vec{B}_1.$$

Maxwell's theorem

The work of the electromagnetic forces exerted during displacement of an undeformable conductor through which an invariable current flows, placed in a magnetic field, has the following expression:

$w = i \Phi$ or Φ is the flow of the magnetic field swept during the displacement.

Used in the form of elementary work, it easily obtains the components F_x , F_y and F_z of the resultant \vec{F} of the electromagnetic forces:

$$\begin{aligned} dw &= i d\Phi \\ &= \int d\vec{f} \cdot d\vec{\ell} \\ &= \vec{F} \cdot d\vec{\ell} \text{ hence} \\ F_x &= i \frac{\delta\Phi}{\delta x} \end{aligned}$$

and likewise for F_y and F_z .

fig. 1: reminder of physical laws.

According to the geometry of the conductor system considered and to the calculation difficulty, one of the three approaches (1)+(3), (2)+(3) or (4), can be used.

However the results obtained may differ slightly according to the approach used since the assumptions on which these laws are established are not the same.

calculation for two parallel stranded conductors of infinite length

For simple geometries such as filiform rectilinear conductors, application of Biot and Savart's and of Laplace's law results in the **classical formula for electrodynamic force between two current lines**;

$$F/\ell = 2 \cdot 10^{-7} I_1 I_2/d$$

where :

F/ℓ in **N/m**,
 I_1 and I_2 in **A**,
 d in **m**,

(The coefficient 2×10^{-7} results from the ratio $\mu_0/4 \pi$).

As this formula acts as a basis throughout this study, we must specify the assumptions for which this expression is valid.

■ the conductors are reduced to a current line. Their cross-section is thus reduced to a point. In practice this condition is considered acceptable for conductors of all cross-sections if the distance between the two conductors is considerably larger than the largest transverse dimension of the conductors (e.g. ten times).

■ the conductors are considered to be rectilinear and infinitely long. In practice this condition may be considered satisfactory if they are at least 15 to 20 times longer than the distance between them.

Whenever one of these assumptions is not valid, a corrective factor must be applied.

influence of conductor shape

This formula of F/ℓ only applies to current lines. However for solid conductors this assumption is not

always valid. In this case the influence of conductor shape may be determined by considering the conductor cross-section as a superimposition of interacting current lines. This approach was made by Dwight for a conductor with a rectangular cross-section.

The resulting corrective factor, conventionally denoted k , can be determined by calculation. However as the expression of k is relatively complex, its value is determined in most cases on the S-shaped curves as in figure 2.

The equation then has the form:

$$F/\ell = 2 \cdot 10^{-7} I_1 I_2 (k/d)$$

where :

F/ℓ in **N/m**,
 I_1 and I_2 in **A**,
 d in **m**.

Examples of forces withstood by two parallel bars on a short-circuit are given in the table in figure 3.

Although the same approach can be followed for all conductor shapes, calculations quickly become tiresome. In the above equation the term (k/d) is often replaced by $1/D$, where D stands for the distance between the conductors corrected to allow for the influence of their shape.

These coefficients are also useful in the case of a set of three-phase conductors

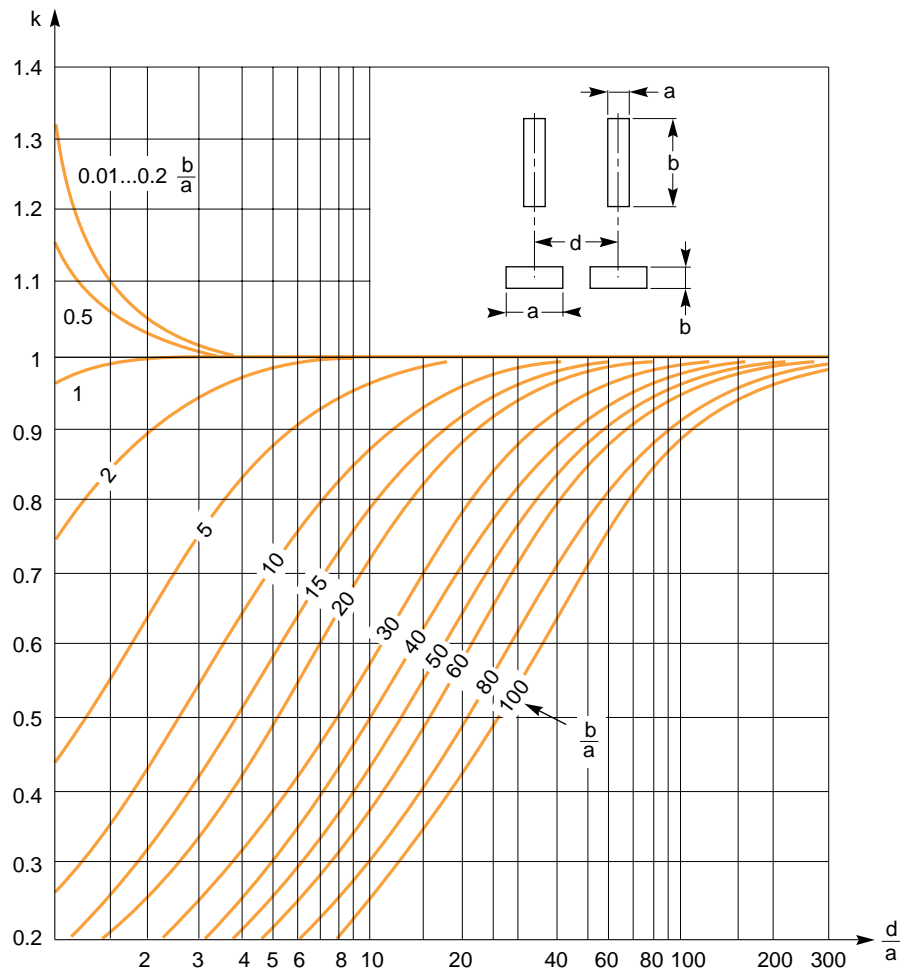

Fig. 2: variation of k as a function of ratios b/a and d/a (Dwight's chart).

containing several conductors per phase. This case is dealt with in chapter 3.

conductors of reduced length

■ conductors of identical length
When conductors have the same length ℓ , 15 to 20 times smaller than their centre distance d , the resulting force is:

$$F = 2 \cdot 10^{-7} \cdot I^2 \cdot \frac{\ell}{D} \left[\sqrt{1 + \frac{d^2}{\ell^2}} - \frac{d}{\ell} \right]$$

■ conductors of unequal length (see fig. 4)

In this case the resulting force is:

$$F = 2 \cdot 10^{-7} \cdot I^2 \cdot \frac{\ell}{D} [C1 + C2]$$

where

$$C1 = \sqrt{\left(1 + \frac{c_1}{\ell}\right)^2 + \frac{d^2}{\ell^2}} - \sqrt{\frac{c_1^2}{\ell^2} + \frac{d^2}{\ell^2}}$$

and

$$C2 = \sqrt{\left(1 + \frac{c_2}{\ell}\right)^2 + \frac{d^2}{\ell^2}} - \sqrt{\frac{c_2^2}{\ell^2} + \frac{d^2}{\ell^2}}$$

The values of C1 and C2 can be read on the chart in figure 5.

If the conductors do not face each other over the entire length, with one passing over the other, the formula applies with c_1 or c_2 negative.

NB

If $c/\ell = 0$, the equation is F in the above paragraph. The value of the expression between square brackets is given directly by reading the relevant curve on the chart in figure 5.

non-rectilinear conductors

This is, for example, the case of conductors with a bend (see fig. 6). The branches may interact with one another when a strong current passes through them.

The conductor b may pivot around point O of the fixed conductor a. Force F has the following value:

$$F = 2 \cdot 10^{-7} \cdot I^2 \cdot \frac{a}{b} \cdot \ell \left[\frac{a}{b} + \sqrt{1 + \frac{b^2}{a^2}} \right] \frac{1 - \cos\alpha}{\sin\alpha}$$

This formula can be used only for values of a and b

such that: $1 < \frac{a}{b} < 10$

calculation in the case of complex configurations

The busbar configurations considered up to now in this study were mainly mono-dimensional, or sometimes two-dimensional in the case of conductors forming an angle. In these cases, the methods used to calculate electrodynamic forces result in relatively simple formula.

However conductors can be arranged in many different ways or be associated with a «disturbing» environment, such that the above formulae cease to apply.

Such arrangements are referred to as «complex configurations».

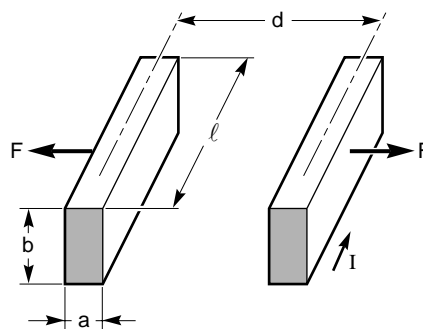

characteristics			forces			
a	b	d	ℓ	k	I	F
mm	mm	mm	m		kA	daN/m
5	80	100	1	0.91	35	224
5	80	100	1	0.91	80	1170

fig. 3: characteristics required to calculate the forces F between two conductors of the same length. Examples of forces withstood by two parallel bars during a short-circuit.

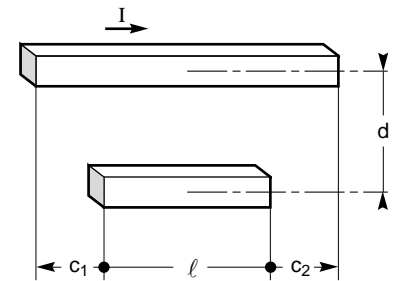

fig. 4: drawing showing two conductors of unequal length.

$$C = \sqrt{\left(1 + \frac{c}{\ell}\right)^2 + \frac{d^2}{\ell^2}} - \sqrt{\frac{c^2}{\ell^2} + \frac{d^2}{\ell^2}}$$

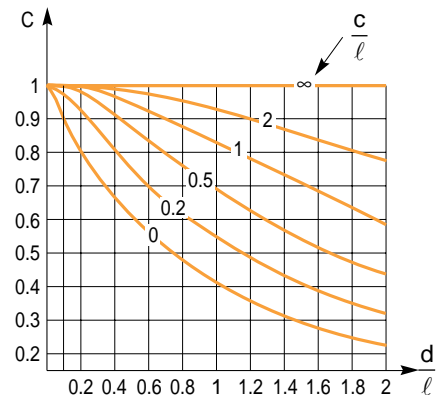

fig. 5: calculation and variation of C as a function of the ratios c/ℓ and d/ℓ .

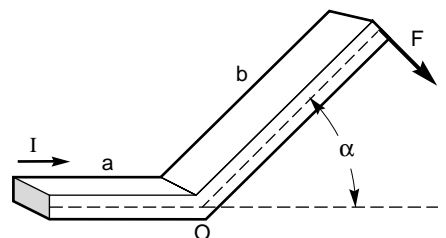

fig. 6: drawing showing two part of conductors (a and b) with a bend.

Three types of problems may then arise, either separately or combined:

- the conductors facing one another are not all in the same plane: the problem is three-dimensional;
- the conductors are close to metal frames which may alter the distribution of the magnetic field surrounding them;
- the conductors are arranged so that it may be necessary to allow for skin effect and proximity phenomena which may considerably alter current distribution in the cross-section of solid conductors.

Calculation of electrodynamic forces for the three types of problems mentioned above uses the general approach described in the paragraph on «origin and calculation method», namely calculation first of the value and distribution of the magnetic field at each point in the system, then of the stresses in the conductors. The problem is thus divided into two to yield a magnetic and a mechanical problem.

The basic physical laws used are therefore the same. However the difficulty, compared with the simple cases, lies in performing the calculations, as the three-dimensional aspect requires a numerical approach. Numerous methods have been developed in recent years to

numerically solve the problems described by differential equations. In particular the finite elements method, initially developed for mechanical problems, has been extended to a wide range of sectors and notably that of electromagnetism.

In short, to define the calculation scope, this method consists of breaking down the system studied into a certain number of elements constituted and connected with one another by points known as nodes. The quantities which are of interest to us (magnetic field, stresses) are determined numerically at each node by solving the relevant equations (Maxwell and elasticity).

Consequently, the value of each quantity studied is not known exactly at all points of the system but only at node level. Hence the importance of ensuring a good correspondence between these nodes and the real system, and of having a sound meshing. In practice, calculation using this method is made up of the following stages:

- choice of the analysis type (e.g. magnetism...);
- choice of type of elements to describe the system;
- definition of the system geometry and of the calculation scope using key points;

- choice of meshing parameters and meshing of the calculation scope with the type of elements chosen; at this stage, the system studied is merely a set of nodes;
- definition of boundary conditions to solve the equations;
- carrying out the calculation;
- using the results.

A wide range of calculation software is available, differing by the categories of problems they can solve and the reliability of the results that they yield. For example Merlin Gerin has chosen the ANSYS software and Telemecanique Flux 2D since:

- they enable very different problems to be dealt with (thermal, mechanical, electromagnetism...),
- they are open-ended; thus their latest versions enable different problems to be paired (magnetic and mechanical or mechanical and thermal...).

It is true that these methods may seem cumbersome and call for considerable investment. However with thorough mastery of the problems relating to modelling techniques, they allow rapid evaluation of the behaviour of a system or of one of its parts other than by tests. This is especially appreciable during the design and development phases when you consider the cost of a test campaign.

3. electrodynamic forces in a three-phase busbar on a two or three-phase fault

Consideration of three-phase busbar peculiarities when designing busbars for LV switchboards and prefabricated ducts, and of the peculiarities relating to the establishment and type of fault, is achieved by integrating factors into the formule presented in chapter 2.

These peculiarities are:

- relative layout of phases (conductors in ribbon, staggered...),
- phase shift of currents in each phase with respect to one another,
- type of short-circuit (two or three-phase),
- short-circuit making characteristics (symmetrical or asymmetrical state),
- the peak current value,
- the alternating aspect of currents, hence the vibrating aspect of the phenomena they generate.

In the remainder of this section, the study will consider only busbars in ribbon, where phases 1,2, 3 are set out in the same plane and with the same distance between phases.

The aim is to determine, by analysing the change in electrodynamic forces as a function of time and the various parameters above, the maximum value

of these forces and the conductor with the highest mechanical stress.

As the electrodynamic forces of the current are proportional to the square of its maximum amplitude, the short-circuit currents need to be studied.

reminder on short-circuit current making

The aim of this paragraph is to review and specify:

- the various short-circuit types that can arise in a three-phase system,
- the notions of symmetrical and asymmetrical state,
- the procedure to follow to determine the expression of short-circuit currents and the parameters on which they depend.

The short-circuit types

There are four types on a three-phase network. These types are shown in figure 7.

Expression of short-circuit currents in the case of a three-phase fault

We shall now concentrate only on symmetrical three-phase faults and

isolated two-phase faults which have the advantage, in steady state, of behaving like one or two independent single-phase networks.

Let us consider a fault occurring on the single-phase diagram in figure 8 in which R and L ω are network impedance elements. If we set as the origin of time, the moment when the short-circuit occurs, the e.m.f. (e) of the generator has the value:

$$e = \sqrt{2} E \sin(\omega t + \alpha)$$

where α is the energising angle (see fig. 9) corresponding to the offset in time between a zero of the e.m.f. and the moment when the short-circuit was made.

Ohm's law applied to the circuit yields:

$$e = R i + L \frac{di}{dt}$$

If the current is nil before the short-circuit is made, the solution for this equation is:

$$i(t) = \sqrt{2} I \left[\sin(\omega t + \alpha - \varphi) + \sin(\varphi - \alpha) e^{-t/\tau} \right]$$

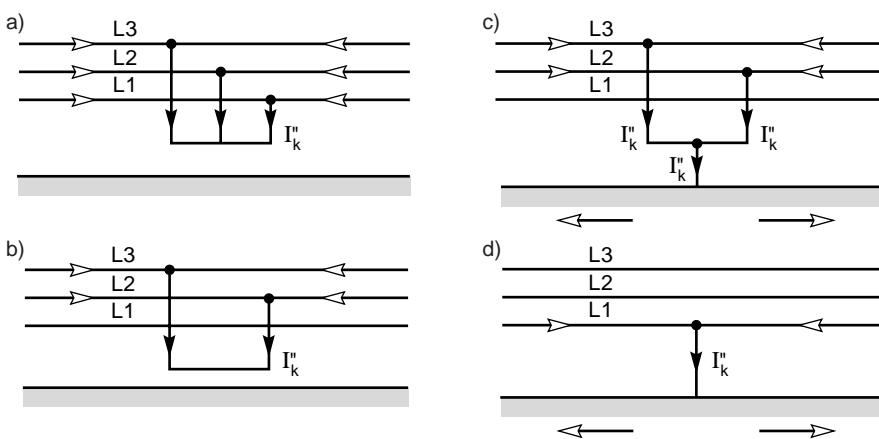

- a) symmetrical three-phase short-circuit.
b) short-circuit between phases, isolated or two-phase.

- c) short-circuit between phases, with earthing.
d) phase-earth short-circuit

fig. 7: the various short-circuits and their currents. The direction of the arrows showing the currents are random (see IEC 909).

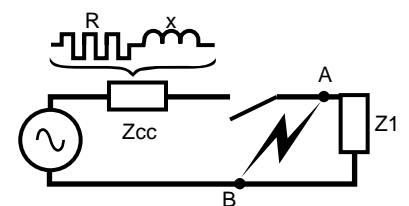

fig. 8: equivalent single-phase diagram on a three-phase fault (see IEC 909).

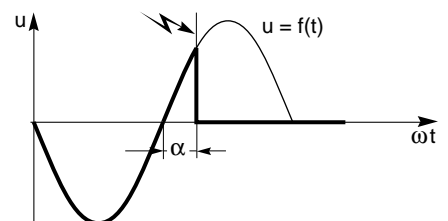

fig. 9: representation of α known as the energising angle.

where :

$$\varphi = \arctg \frac{L \omega}{R} \quad (\text{impedance angle})$$

$$\tau = \frac{L}{R}$$

$$I = \frac{E}{\sqrt{R^2 + L^2 \omega^2}}$$

All the factors representing the current variation as a function of time are then grouped in the following equation:

$$\kappa = \left[\sin(\omega t + \alpha - \varphi) + \sin(\varphi - \alpha) e^{-t/\tau} \right]$$

The term κ can also be calculated using the approximate formula defined by IEC 909:

$$\kappa = 1.02 + 0.98 e^{-\frac{3R}{L\omega}}$$

The difference with the exact value is less than 0.6%.

Analysis of this function enables definition of the symmetrical and asymmetrical states of a fault (cf. «Cahier Technique» n° 158). In the case of a three-phase system, the current in each phase takes the form:

$$i_1(t) = \sqrt{2} I_{rms,3ph} \left[\sin(\omega t + \alpha - \varphi) + \sin(\varphi - \alpha) e^{-t/\tau} \right]$$

which can also be written as:

$$i_1(t) = \sqrt{2} I_{rms,3ph} \kappa$$

where $I_{rms,3ph}$ stands for the symmetrical root mean square current in the three phases in steady state.

In view of their relative phase shift:

■ i_2 same as i_1 by replacing α by $\alpha + 2\pi/3$

■ i_3 same as i_1 by replacing α by $\alpha - 2\pi/3$.

Finally, the electrodynamic forces thus depend on :

■ the initial instant of the short-circuit (via the value of α) ;

■ the characteristics of the circuit (via the value of φ) ;

■ the phase shift between the phases ($2\pi/3$).

maximum force on a three-phase busbar

A three-phase busbar normally contains three conductors placed side

by side. Thus each conductor undergoes at a time t a force which results from the algebraic addition of its interactions with the two other conductors. These conductors can have only two situations, external or central:

■ external position, for example phase 1:

$$F_1(t) = F_{2 \rightarrow 1}(t) + F_{3 \rightarrow 1}(t)$$

$$F_1(t) = cF [i_1(t) i_2(t) + i_1(t) i_3(t)/2]$$

cF is a function of distance between bars and bars shape.

■ central position, for example phase 2:

$$F_2(t) = F_{1 \rightarrow 2}(t) - F_{3 \rightarrow 2}(t)$$

$$F_2 = cF [i_1(t) i_2(t) - i_2(t) i_3(t)]$$

However, as seen in the above paragraph, there are many cases to be considered for current expression according to the value of α , φ , and of the type of short-circuit.

In actual fact, only the value of the maximum forces is required to size the busbars: this value is the highest current occurring when $\alpha = 0$.

NB:

$F_{a \rightarrow b}$ = action (force) of the conductor(s) of phase a on the conductor(s) of phase b.

Case of a three-phase short-circuit

The effects on the conductors take the form:

$$F_1 = 0.87 [i_1(t) i_2(t) + i_1(t) i_3(t)/2]$$

$$F_2 = 0.87 [i_1(t) i_2(t) - i_2(t) i_3(t)]$$

The maximum force on conductors over time is determined by the time values which cancel the derivatives of these expressions with respect to time: $dF_1/dt = 0$ et $dF_2/dt = 0$.

Hence, after a few calculations, where

$$I_{max,3ph} = \sqrt{2} I_{rms,3ph} \kappa$$

the two equations:

$$\blacksquare F_{1max,3ph} =$$

$$2 \cdot 10^{-7} \cdot 0.808 (\sqrt{2} I_{rms,3ph} \kappa)^2 / d$$

(case of one of the conductors external to the three-phase busbar)

$$\blacksquare F_{2max,3ph} =$$

$$2 \cdot 10^{-7} \cdot 0.866 (\sqrt{2} I_{rms,3ph} \kappa)^2 / d$$

(case of one of the conductors external to the three-phase busbar)

Note:

■ compared with the reference formula reviewed in chapter 2

$$F/\ell = 2 \cdot 10^{-7} I_1 I_2/d$$

the additional corrective factor which, according to the position of the conductor under consideration, equals 0.808 or 0.866. The maximum force is thus generated on the central conductor.

■ in practice, the coefficient k takes the circuit characteristics (R and L) into consideration: its value is between 1 and 2 (see fig. 10).

Case of a two-phase short-circuit

In this case $i_1 = -i_2$ and, using the above formulae, we can show that the maximum electrodynamic forces are reached when $\alpha = 0$ (asymmetrical state).

$$F_{2max,2ph}$$

$$= 2 \cdot 10^{-7} \cdot 1 (\sqrt{2} I_{rms,2ph} \kappa)^2 / d$$

Remarks

The maximum force is not shown in two-phase, as it is often thought, but in three-phase.

In actual fact:

$$\frac{F_{2max,3ph}}{F_{2max,2ph}} = \frac{0.866 I_{rms,3ph}^2}{I_{rms,2ph}^2}$$

however in the three-phase distribution state:

$$I_{rms,2ph} = \frac{\sqrt{3}}{2} I_{rms,3ph}$$

which yields the ratio:

$$\frac{F_{2max,3ph}}{F_{2max,2ph}} \approx 1.15$$

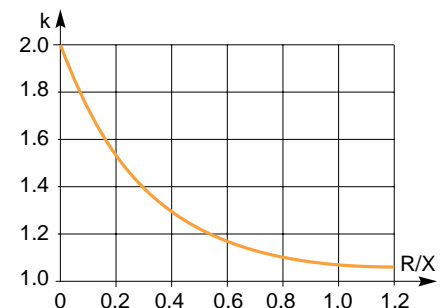

fig. 10: variation of factor k as a function of the ratio R/X .

Test organisations often demand two and three-phase tests with currents of identical value. These test conditions do not correspond to real distribution characteristics and result in two-phase forces which are greater than three-phase forces.

resonance phenomena

Forces appearing on a short-circuit do not form a static phenomenon, but are vibrating quantities of a frequency twice that of the network or of its multiples. Conductors which have a certain elasticity can then start to vibrate. If the vibration frequency corresponds to a natural frequency for all conductors, resonance phenomena may occur. In this case the resulting stresses in the conductors may be far greater than those created by the forces due to the peak current value. It is thus necessary to determine the ratio between the real and static forces undergone by the conductor. This ratio conventionally denoted V_{σ} is known as the stress factor. In addition to the mechanical characteristics of the conductors, we must allow for the way in which they are secured in the device housing them (LV switchboard, duct...). We thus need to reason on the «**busbar structure**». There are two standard methods for securing busbars: flush mounting and simple support. However in reality the insulating elements support the conductors, which results in a combination of these two methods (see fig. 11).

The large number of parameters to be considered makes a complete study of these phenomena complex. The starting point for such a study is the general equation applied to a conductor assumed to have an elastic behaviour:

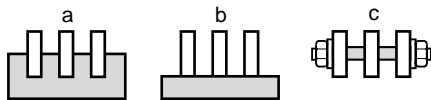

fig. 11: the various busbar securing methods: by flush mounting (a), by simple support (b) and a combination of both (c).

$$F(t) = M \frac{\delta y^2}{\delta t^2} + \lambda \frac{\delta y}{\delta t} + E J \frac{\delta y^4}{\delta x^4}$$

where:

M = mass of the conductor per unit of length,

J = moment of inertia of the cross-section perpendicular to the conductor axis,

E = modulus of elasticity,

λ = damping coefficient,

y = distance from a point of the conductor with respect to its position of equilibrium or deflection,

x = distance from a point of the conductor with respect to a fixed bearing,

t = time.

where $F(t) = F_0 \sin(2 \omega t)$

where:

F_0 = amplitude of the force,

ω = network pulsation ($\omega = 2 \pi f$).

The solutions take the form:

$y = \text{cste } F_k(t) G_k(x)$

where the functions $F_k(t)$ and $G_k(x)$ depend on time and on the space variable respectively, as well as on:

- the securing methods,
- the electrodynamic force relating to the short-circuit state (symmetrical or asymmetrical).

The complete study was conducted by Baltensperger and leads to an

expression of conductor natural resonance frequencies:

$$\omega_{ok} = \frac{S_k^2}{p^2} \sqrt{\frac{E J}{M}}$$

where

S_k = coefficient function of the securing methods, for example for a bar flush mounted at its ends:

$$S_k = (4k - 1) \pi / 2 ;$$

k = rank of resonance frequency;

p = distance between the supports.

In practice, we observe that natural conductor frequencies, for a specific cross-section, depend on the longitudinal distance between supports. The calculation therefore aims at examining whether the stress factor, resulting from the selected distance between the supports, is acceptable for the natural frequency of the conductor or all the conductors, resulting in a coefficient R, homogenous with a length:

$$R = 4 \sqrt{\frac{E J}{M \omega^2}} 10^3$$

The graph in figure 12 shows the stress factor V_{σ} to be anticipated as a function of the ratio p/R, i.e. of the distance p between the supports. p must be chosen so that the ratio is outside the hatched zone for the accepted factor V_{σ} .

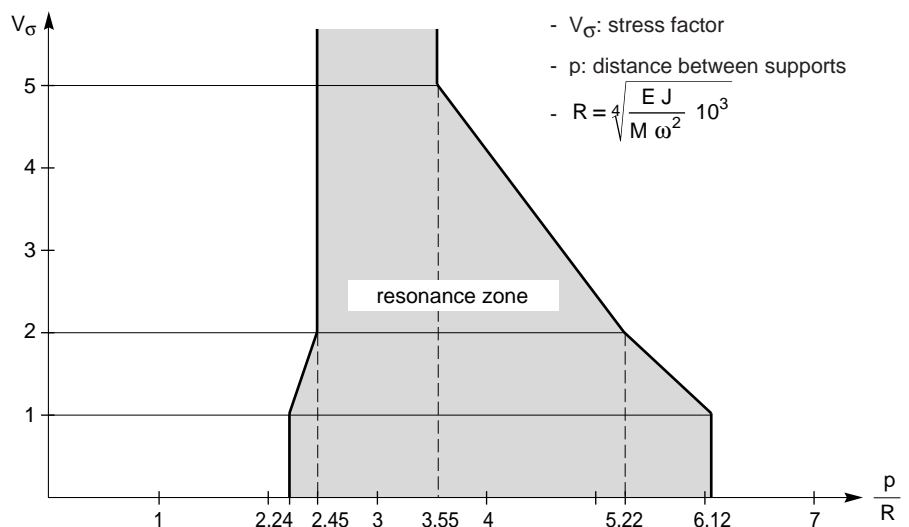

fig. 12: stress factor V_{σ} to be anticipated as a function of the ratio p/R.

4. application to LV three-phase busbars

In this chapter the authors define how the above theoretical considerations are taken into account for two LV items of equipment, namely LV switchboards and prefabricated electrical ducts of the Canalis and Victa Dis type.

case of busbars in LV switchboards

The three-phase busbar of a LV electric switchboard is made up of a set of conductors grouped by phase and held in place by supports.

It is characterised by:

- the shape of the conductors,
- the relative layout of the phases,
- the arrangement of the conductors in the same phase,
- the type of support and the conductor securing method (insulating bars, combs, insulating rods...).

The various elements making up the busbar system must be sized to withstand the electrodynamic forces which appear when a short-circuit occurs (see fig. 13).

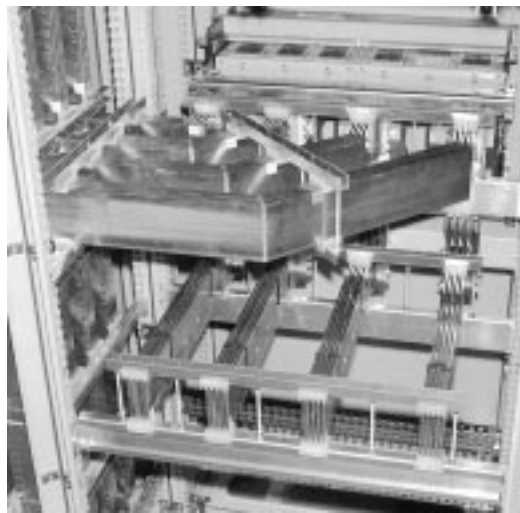
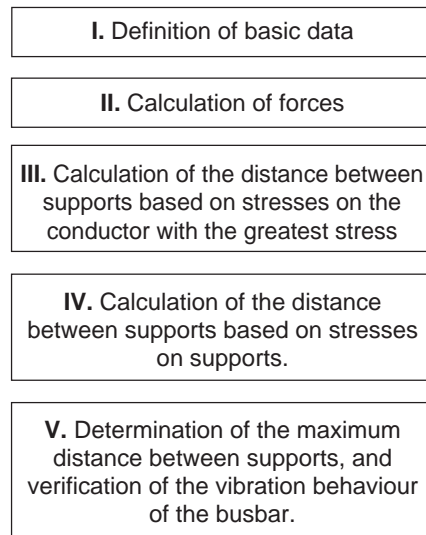

fig. 13: busbar of a Masterbloc LV switchboard, designed to withstand the effects of a 80 kA short-circuit current (Merlin Gerin).

In practice, sizing requires determination of the distance between the supports and thus the number required, for a specific busbar and support technology.

Practical calculation procedure

The method to be followed is summarised in the chart below:



The details of each stage are described below for a busbar consisting of several rectangular cross-section bars per phase.

I - Basic data for carrying out the calculation

- dimension and shape of a conductor (for example for a bar, its thickness a and its width b in **m**.)
- number of conductors per phase: n .
- root mean square value of the short-circuit current: I_{sc} in **kA**.
- type of fault: two or three-phase.
- distance between phase centres: d_{ph} in **m**.
- conductor securing method in the supports (flush mounting or simple support). This data is taken into account by a coefficient β :
 $\beta = \beta_1$ for all the conductors of a phase,
 $\beta = \beta_2$ for a conductor belonging to one phase,
- elastic limit of the conductor:
 $R_{p0.2}$ in **N/m²**
 $(R_{p0.2} = 125 \times 10^6 \text{ N/m}^2 \text{ for } 1050 \text{ type aluminium and } R_{p0.2} = 250 \times 10^6 \text{ N/m}^2 \text{ for copper}).$
- characteristics of supports:
mechanical withstand R_m (in **N/m²**) according to the type of stress, and cross-section of the stressed support S_m (in **m²**).

II - Calculation of forces

Each conductor of a phase is subjected to a force due to the actions between phases and to the actions of the other conductors of the same phase. The maximum force is exerted on the most external conductors of the central phase. This conductor is subjected:

- firstly to the force resulting from the other two phases:

$$F1/\ell$$

$$= 0.87 \text{ (or } 1) \cdot 2 \cdot 10^{-7} \cdot k_1 \cdot (2.2 \cdot I_{sc})^2 \cdot 1/d_{ph}$$

0.87 : if the fault is three phase

1 : if the fault is two phase

(force per unit of length of the busbar in **N/m**).

k_1 = Dwight's coefficient allowing for the shape of all the conductors of the phase.

This coefficient, parameterised by the ratios height (h)/width of a phase (I') and d_{ph} /width of a phase, can be calculated or read on charts.

I_{sc} = root mean square value of the short-circuit current in **kA**.

d_{ph} = distance between phase centres in **m**.

The multiplying factor 2.2 is used to calculate the peak value of the short-circuit current.

■ secondly to the force of attraction (current in the same direction) resulting from the other conductors of the phase considered (see fig. 14), if these are mechanically linked:

$$F2 / \ell = \sum_i F2_{1 \rightarrow i} / \ell \text{ (in N/m)}$$

Equation of the same form as the one above, but taking into account the following three parameters:

$d_{1 \rightarrow i}$ = centre distance from conductor 1 to conductor i in **m**,
 n = number of conductors per phase,
 k_2 = Dwight's coefficient for the phase conductor.

III - Calculation of the distance between supports based on stresses on the conductor with the greatest stress

The conductor with the greatest stress must withstand the stress:

$$\sigma = \sigma_1 + \sigma_2 = \frac{\beta_1 (F1/\ell) d_1^2}{8 Z} + \frac{\beta_2 (F2/\ell) d_1^2}{8 Z_0}$$

$F1/\ell$ and $F2/\ell$ = forces in **N/m**,
 d_1 = distance between two supports in **m**,
 Z_0 = resistance module of a bar in **m³**,
 Z = resistance module of a phase in **m³**,
 $\beta_1 = 0.73$ (simple support coefficient),
 $\beta_2 = 0.5$ (flush mounting coefficient).
 These values are given by way of guidance for a specific busbar

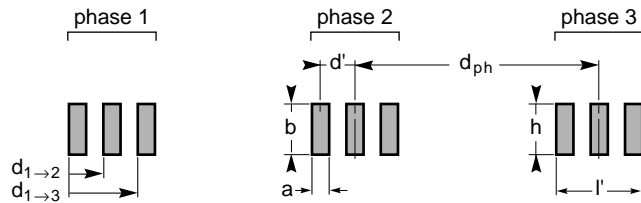

here $b = h$
 $k_1 = f(h, I', d_{ph})$
 $k_2 = f(a, b, d')$

fig. 14: parameters considered to establish the equation for the force of attraction between busbar conductors

configuration; bars of the same phase are flush mounted and the three phases positioned (see fig. 15).

«Busbar deformation» criterion

The bar with the greatest stress must not be deformed. However a slight residual deformation is accepted according to a coefficient q defined by the IEC 865 standard.

The above formula includes d_1 . This distance between supports can be determined from a maximum stress level at the conductors which must not be exceeded, such that $\sigma = q \cdot R_{p0.2}$ (for example $q = 1.5$).

IV - Calculation of the distance between supports based on stresses on supports

The supports must therefore withstand the stresses linked to the force F_1 .

«Support break» criterion:

$$d_2 = \frac{R_m S_m}{\alpha F_1 / \ell}$$

where
 α = constant whose value depends on the securing method and the number of supports.

V - Determination of the maximum distance between supports, and verification of the busbar vibration behaviour

In order to withstand electrodynamic forces, the supports must be placed at

a distance d equal to the smallest value of d_1 and d_2 :
 $d \leq \min(d_1, d_2)$.

Moreover you must ensure that this distance does not generate resonance phenomena.

This calculation procedure complies with the recommendations of the IEC 865 standard (1986) dealing with calculation of the effects of short-circuit currents as regards both the thermal and mechanical aspects.

Although these calculations do not replace real-life tests, they are vital for designing new products and for satisfying specific cases.

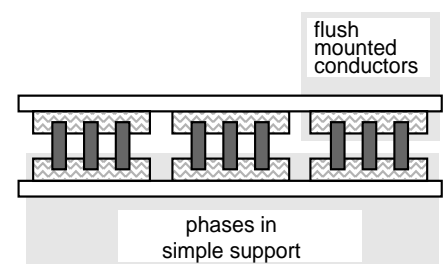

fig. 15: configuration of a busbar for coefficients $\beta_1 = 0.73$ (simple support) and $\beta_2 = 0.5$ (flush mounting).

Calculation example

I. definition of basic data

■ conductors

flat copper bars

thickness **a = 5 mm**

width **b = 100 mm**

securing: **flush mounted bars**

■ each phase is made up of

n = 3 bars, with a 5 mm spacing ($d' = 10$ mm)

■ distance between phase centres

d_{ph} = 95 mm

■ three-phase fault **I_{sc} = 80 kA rms**

■ elastic limit of copper

R_{p0.2} = 250 x 10⁶ N/m²

■ mechanical withstand of support

R_m = 100 x 10⁶ N/m²

■ cross-section of support subjected to tensile stress

S_m = 150 x 10⁻⁶ m²

II. calculation of forces

■ **between phases**

$F1/\ell = 0.87 \cdot 2 \cdot 10^{-7} \cdot k1 \cdot (2.2 \cdot I_{sc})^2 \cdot 1/d_{ph}$

k1 : Dwight's coefficient, function of the ratios $b/(2n - 1) \cdot a$ and $d_{ph}/(2n - 1) \cdot a$

$k1(100/5 \cdot 5, 95/5 \cdot 5) = 0.873$

■ **between bars of the same phase**

particularly on the external bars of the central phase

$F2/\ell = \sum_i F2_{1,i} / \ell$

1 index of the first bar

i = 2 and 3 index of the two other bars of the phase

$F2_{1,i} / \ell = 2 \cdot 10^{-7} \cdot k2_{1,i} \cdot (2.2 \cdot I_{sc}/n)^2 \cdot 1/d$

$d_{1 \rightarrow i}$: distance between the axis bars 1 and i

$k2_{1,i}$: Dwight's coefficient as a function of ratios b/a and $d_{1 \rightarrow i}/a$

$k2_{1,2}(100/5, 10/5) = 0.248$

$k2_{1,3}(100/5, 20/5) = 0.419$

III. Calculation of the distance between supports based on stresses on the conductor with the greatest stress (elastic limit of conductor)

$\sigma = \beta_1 (F1/\ell) \cdot d_1^2/8 \cdot Z + \beta_2 (F2/\ell) \cdot d_1^2/8 \cdot Z_0$

$\sigma = 1.5 \cdot R_{p0.2}$

$d_1^2 = 1.5 \cdot R_{p0.2} / [\beta_1 (F1/\ell)/8 \cdot Z + \beta_2 (F2/\ell)/8 \cdot Z_0]$

$\beta_1 = \beta_2 = 0.5$

$Z_0 = b \cdot a^2/6 = 4.2 \cdot 10^{-7} \text{ m}^3$

$Z = n \cdot Z_0 = 3 \cdot Z_0 = 1.25 \cdot 10^{-6} \text{ m}^3$

$F1/\ell =$

$0.87 \cdot 2 \cdot 10^{-7} \cdot 0.873 \cdot (2.2 \cdot 80 \cdot 10^3)^2 \cdot 1/95 \cdot 10^{-3}$

$F1/\ell = 49\,530 \text{ N/m} = \mathbf{4\,953 \text{ daN/m}}$

$F2/\ell =$

$2 \cdot 10^{-7} \cdot (2.2 \cdot 80 \cdot 10^3/n)^2 \cdot [0.248/10 \cdot 10^{-3} + 0.419/20 \cdot 10^{-3}]$

$F2/\ell = 31\,490 \text{ N/m} = \mathbf{3\,149 \text{ daN/m}}$

IV. Calculation of the distance between supports based on stresses on the supports (elastic limit of supports)

$d_2 = R_m \cdot S_m / (F1/\ell)$

$\alpha = 0,5$

$d_2 = 100 \cdot 10^6 \cdot 150 \cdot 10^{-6} / (0.5 \cdot 49\,530)$

$d_2 = 0.604 \text{ m} = \mathbf{604 \text{ mm}}$

V. determination of the maximum distance between supports

$d = \text{minimum entre } d_1 \text{ et } d_2$

$d < \mathbf{229 \text{ mm}}$

Standards and tests

There are two test categories for LV equipment, namely:

- development tests assisting with design,
- certification tests.

The latter are part of a set of tests known as «type tests» whose reports are frequently demanded for a product defined as a «Type tested assembly» (T.T.A.).

This designation, which requires tests, thus forms an additional guarantee for users. However, despite this constraint, manufacturers develop products which allow them to valorise their know-how.

The type tests defined by the standards IEC 439-1 (1992) and 2 (1987) or NF 63-421 (1991) total 7 (439-1) and 10 (439-2) respectively.

As regards short-circuit withstand, which is the subject of this document, these standards specify both the test conditions to be complied with and the standardised value of the coefficient connecting the peak value to the root mean square value of the short-circuit current (see fig. 16).

If the system considered varies only slightly from the reference system (T.T.A.), it is known as a «Partially type tested assembly» (P.T.T.A.) and it can

be qualified by calculation from an T.T.A. structure.

With respect to short-circuit current withstand, an extrapolation method for the P.T.T.A. has been defined by the technical report IEC 1117 (1992).

Complete certification in short-circuit current withstand requires three tests:

- a three-phase short-circuit current withstand test;
- a withstand test for a short-circuit current between the neutral and the nearest phase. Note that if the neutral has the same cross-section as the other phases and if the distance between the neutral and the nearest phase is the same as the distance between phases, this test corresponds to a two-phase short-circuit;
- a withstand test for a short-circuit between a phase and the protective conductor.

For each test the manufacturer must specify the root mean square value of the short-circuit current and its duration, normally 1 s (to verify the thermal constraint linked to the short-circuit current).

As regards the value of the short-circuit current for the three-phase test, two values must be identified: **the prospective value and the real value.** Their difference is due to whether or

not the busbar impedance is taken into account during calculation. In practice:

- calculation performed with a voltage equal to the operational voltage, at the entrance to the switchboard \Rightarrow presumed value of I_{sc} ;
- calculation performed, at extra-low voltage, at the end of the busbar at the short-circuit point \Rightarrow real value.

It is obvious that for the same announced value of the short-circuit current strength, the second case is far more restrictive. The difference may range from 20 to 30% according to the circuit.

For the phase-neutral test, the value of the short-circuit current corresponds to 60% of the value of the current (prospective or real) of the three-phase test.

Many manufacturers (including Merlin Gerin and Telemecanique) currently tend to perform these tests in real current. Moreover, to ensure that these tests are representative of the most unfavourable tests possible during a short-circuit, the following points must be complied with:

- presence of an asymmetrical state at least on one of the three phases;
- presence of at least one joint or fishplate on the tested busbar;
- creation of a bolted short-circuit;
- consideration of vibrating phenomena, while maintaining the fault for at least ten cycles, i.e. 200 ms at 50 Hz; this time is often extended to 1 s to check thermal withstand at the same time (IEC 439-1).

The various test stages are:

- calibration circuit by short-circuiting the transformer outputs;
- connecting the busbar to the platform transformer;
- setting up the short-circuit (specific part connecting all the bars) on the busbar;
- short test (roughly 10 ms) to determine busbar impedance;
- 1 s withstand test on the assembly.

root mean square value of the short-circuit current (kA)	$\cos \varphi$	n
$I \leq 5$	0.7	1.5
$5 < I \leq 10$	0.5	1.7
$10 < I \leq 20$	0.3	2
$20 < I \leq 50$	0.25	2.1
$50 < I$	0.2	2.2

fig. 16 : standardised value of the coefficient n connecting the peak value to the root mean square value of the short-circuit current; n correspond to coefficient $\sqrt{2} \kappa$ defined in chapter 3 (ie. IEC 439-1).

case of prefabricated ducts of the Canalis or Victa Dis type

Construction of prefabricated three-phase busbars of the Canalis or Victa Dis type, designed for current transmission and distribution (see fig. 17) complies with proper procedures and with specific standards, the main ones of which are the IEC 439-1 and 2 (international) and UL 857 (United States).

Design

The techniques implemented vary according to the current ranges considered, especially for large currents exceeding 100 A.

There are currently three main duct designs:

- standard,
- sandwich,
- flattened.

■ standard design (100 to 800 A)

The conductors are placed in a metal envelope and maintained at regular intervals by comb shaped insulators (see fig. 18).

The electrodynamic forces developing when short-circuits occur, observe the laws stated above and result in the deflection of conductors between insulators and in an overall vibration.

The shape and cross-section of the conductors result from the best possible balance achieved between:

- temperature rise of conductors;
- acceptable voltage drop;
- production cost.

With the following vital requirements for mechanical withstand: that conductor deflection continues to be elastic (no permanent deformation after a short-circuit) and does not abnormally reduce the insulation level (between phases or between phases and earth) during the short-circuit transient period in which the electrodynamic phenomena are created.

In practice this is obtained by adjusting the distance between insulators.

■ sandwiched design (1000 to 5000 A):

Beyond a certain current, 1000 A, in order to remain within acceptable heat exchange conditions and dimensions for the duct, the current of the same phase is distributed over several

conductors. Some ducts sandwich up to five conductors per phase.

Designers can then either:

- leave the conductors of the same phase grouped together,
- or insert the elementary phase conductors in an orderly manner (1-2-3) + (1-2-3) + (1-2-3) to obtain the «sandwiched» configuration (see fig. 18).

This type of design is ideal for horizontal current distribution.

■ flattened design (1000 to 5000 A):

In this layout, the rectangular cross-section conductors coated with an insulating sheath are kept in contact all along the duct, just as in a cable (see fig. 18). Conductors are clamped to ensure the necessary heat exchanges.

To simplify manufacture, conductors normally have constant thickness, and only their width varies according to nominal busbar current strength (up to roughly 250 mm). For high currents, two or even three conductors per phase, but not sandwiched, are required.

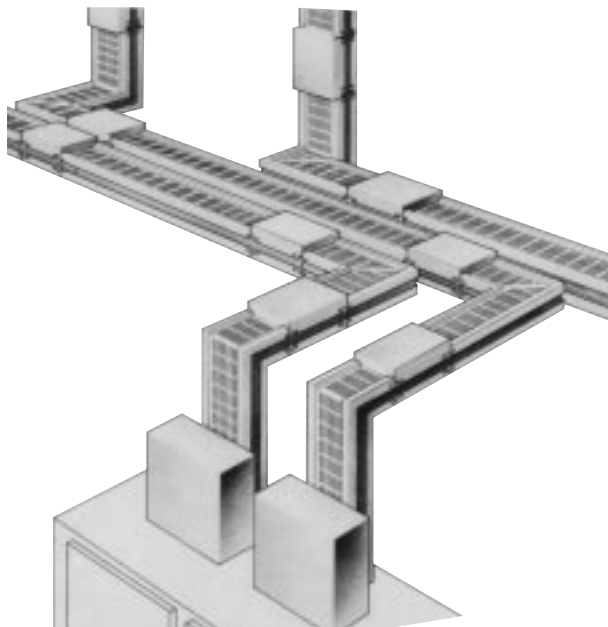

fig. 17: Canalis (Telemecanique) 3000 A electrical distribution prefabricated busbar.

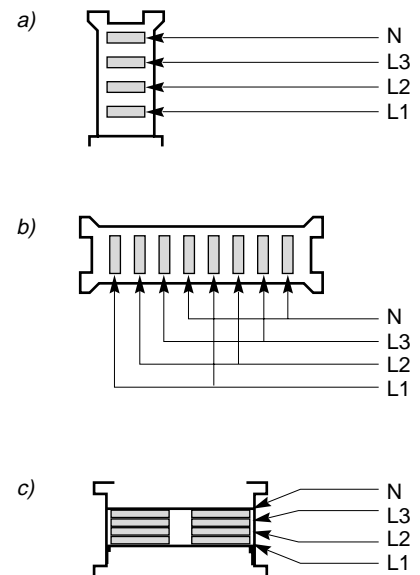

fig. 18: the various prefabricated three-phase busbar designs: standard (a), sandwiched (b) and flattened (c).

The electrodynamic forces (distributed loads) when a short-circuit occurs are balanced in these busbars by the reaction of the envelope sheet metal. Its thermal behaviour means that this type of design is ideally suited to transmission of horizontal or vertical current.

Distribution of electrodynamic forces

This paragraph uses a simple, concrete example to visualise and quantify the

various forces to which conductors are subjected.

The structure studied has the following characteristics:

- $I_n = 3000 \text{ A}$,
- three conductors/phase, i.e. 1000 A/conductor ,
- conductor cross-section = $90 \text{ mm} \times 6 \text{ mm}$,
- material = aluminium or copper,
- distance between conductor centres = 18 mm .

The calculations shown in the box (see fig. 19) evaluate the mechanical stress of the elementary conductors (according to current direction) of phases 1 and 2 for a phase 1/phase 2 two-phase short-circuit with correction of the geometric incidence in accordance with Dwight's chart.

Partial conclusions:

With the standard layout, an increase and large dispersion of the forces applied to the various conductor

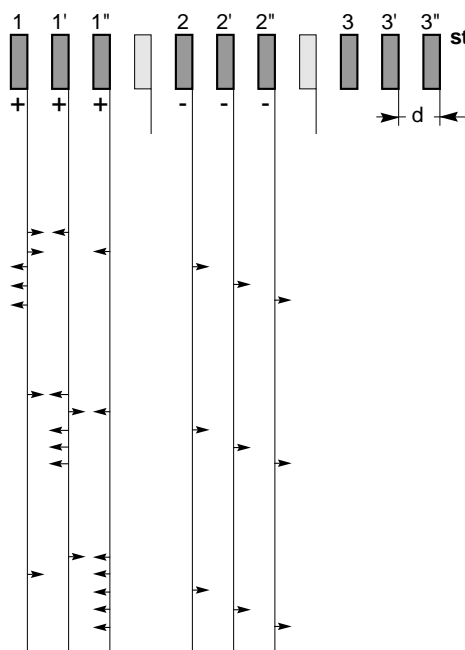

$$F = f(i^2, \cos\phi) \text{ with } i = I / 3$$

$$\sum F_{ph1} = F \left[\left(\frac{1}{d} 0.42 \right) + \left(\frac{1}{2d} 0.62 \right) - \left(\frac{1}{4d} 0.83 \right) - \left(\frac{1}{5d} 0.87 \right) - \left(\frac{1}{6d} 0.92 \right) \right]$$

$$= \frac{F}{d} 0.19 \Rightarrow K1 = 0.19$$

$$\sum F_{ph1'} = F \left[\left(-\frac{1}{d} 0.42 \right) + \left(\frac{1}{d} 0.42 \right) - \left(\frac{1}{3d} 0.75 \right) - \left(\frac{1}{4d} 0.83 \right) - \left(\frac{1}{5d} 0.87 \right) \right]$$

$$= -\frac{F}{d} 0.63 \Rightarrow K1' = 0.63$$

$$\sum F_{ph1''} = F \left[\left(-\frac{1}{d} 0.42 \right) + \left(\frac{1}{2d} 0.62 \right) - \left(\frac{1}{2d} 0.62 \right) - \left(\frac{1}{3d} 0.75 \right) - \left(\frac{1}{4d} 0.83 \right) \right]$$

$$= -\frac{F}{d} 1.49 \Rightarrow K1'' = 1.49$$

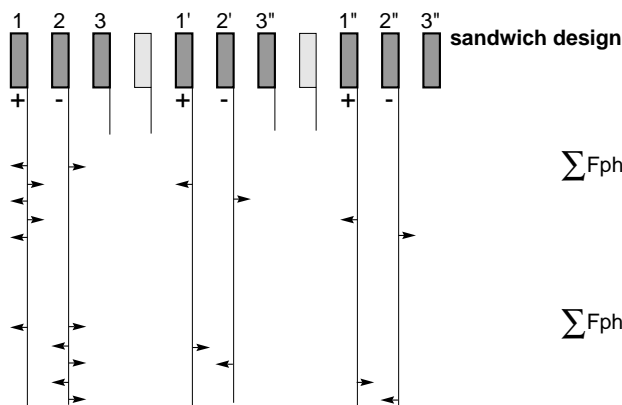

$$\sum F_{ph1} = F \left[-\left(\frac{1}{d} 0.42 \right) + \left(\frac{1}{4d} 0.83 \right) - \left(\frac{1}{5d} 0.87 \right) - \left(\frac{1}{8d} 1 \right) - \left(\frac{1}{9d} 1 \right) \right]$$

$$= -\frac{F}{d} 0.37 \Rightarrow K1 = 0.37$$

$$\sum F_{ph2} = F \left[+\left(\frac{1}{d} 0.42 \right) - \left(\frac{1}{3d} 0.75 \right) + \left(\frac{1}{4d} 0.83 \right) - \left(\frac{1}{7d} 0.97 \right) + \left(\frac{1}{8d} 1 \right) \right]$$

$$= +\frac{F}{d} 0.36 \Rightarrow K2 = 0.36$$

fig. 19: mechanical stress of phase 1 and 2 elementary conductors.

elements are observed, whereas for the sandwich layout, forces remain more or less the same for each conductor element.

In this example, the difference in mechanical stress has a ratio of 1 to 5 in favour of the sandwich layout. Moreover, this layout offers another advantage as for as voltage drop is concerned: «sandwiching» of phases causes a reduction in the magnetic induction resultant and thus in reactance,... i.e. in voltage drop.

Branch-offs and splicing

Two technologies are normally chosen to sample current at the branch-offs or to conduct it in the splice bars of a prefabricated transmission and distribution line. These are «bolted» technology and «contact» technology.

■ «bolted» technology

The connections are made from special bolted pads provided in the equipment design stage.

The above laws are also applied for sizing the pads and insulators.

Application of this technology has the following practical limits:

- 1250 A, in branch-off,
- up to 6000 A in splicing.

NB :

Some articulated bends produced in the same plane use the «bolted» technology principle.

■ «contact» technology

Current conducted using parallel-connected contact fingers.

As a first approach, the current is distributed in proportion to the number of parallel contacts. Each contact point has a static force F (developed by an external spring) whose sizing results from a compromise between the level of the required contact resistance to ensure nominal current flow without abnormal temperature rise, and the friction force withstand during conductor expansion.

With this in mind, we should note the advantage of lubricating the elastic contacts or of using, for mounted contacts, silver/graphite type combinations.

This technology is particularly used in the following current ranges:

- 16 to 400 A in branch-off,
- 40 to 1000 A in splicing.

■ electrodynamic force withstand

Whereas «bolted» technology imposes on the elements of the structure in question the same electrodynamic forces as for the busbars in LV switchboards, «contact» technology benefits from these forces.

The layout normally chosen for the contact fingers or «pawls» is illustrated in the drawing in figure 20 on which it is clearly shown that the currents flowing in opposing pawls run in the same direction. The electrodynamic forces (distributed loads) developed along the pawls and calculated using the above methods thus tend towards an attraction. They consequently reinforce the contact force and oppose the repulsion force of contacts which has as its origin striction of the current lines in the vicinity of the contact point (see fig. 21). This is the self-compensation principle (see fig. 20).

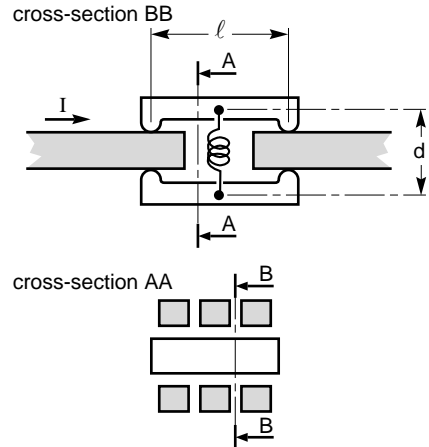

In the calculation, we consider the forces on each half-contact jaws, of cross-section a x b, grouping all the contact elements of jaws.

If n is the number of parallel contact jaws, the total repulsion force on the half-contact jaws is:

$$Fr = 2 n \cdot 3 \cdot 10^{-7} (I2n)^2$$

The force of attraction which has to compensate it is:

$$Fa = 2 \cdot 10^{-7} \left(\frac{I}{2}\right)^2 k \frac{\ell}{d} \left(\sqrt{1 + \frac{d^2}{\ell^2}} - \frac{d}{\ell}\right)$$

fig. 20: the self-compensation principle.

k is the shape factor, to be read off the chart in figure 2, for a conductor with a global cross-section a x b.

If we write Fa = Fr so that compensation is achieved, the result is:

$$\frac{\ell}{d} \geq \sqrt{\left(\frac{3}{n k} + 1\right)^2 - 1}$$

For example, for k = 0.8, the ratio I/d must reach:

4.6	for	1 contact jaw	(n = 1)
2.7	for	2 contact jaws	(n = 2)
1.4	for	5 contact jaws	(n = 5)
0.95	for	10 contact jaws	(n = 10).

Although it may seem interesting to increase the number of parallel contact jaws n, we are quickly limited by technological considerations as well as by differences in resistance and reactance between adjacent contact jaws which do not allow even current distribution between each other such as is assumed by the calculated value of I/d.

We must therefore take a safety margin on the calculated value of I/d, as large as the number of parallel contact jaws is high. In practice, there are applications of up to 2 x 12 parallel contacts which can withstand acceptable short-term currents of the order of 50 kA RMS - 1 s.

Electrodynamic force tests

Type tests, specific to ducts, are defined by the IEC 439-2 and NF C 63-411 standards.

The main difference compared with «LV switchboards» lies in the short-circuit test conditions which specify that the tests must be performed on an installed line no more than six metres long with at least one splice joint and a bend (see sketch in fig. 22).

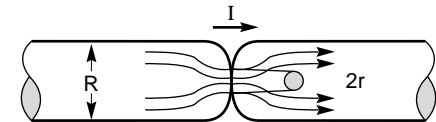

A repulsion force F is exerted between the two conductors:

(In = natural log and r = contact point radius calculated with R. Holm's formula).

fig. 21: example of striction of current lines in the vicinity of the contact point between two cylindrical current-carrying elements

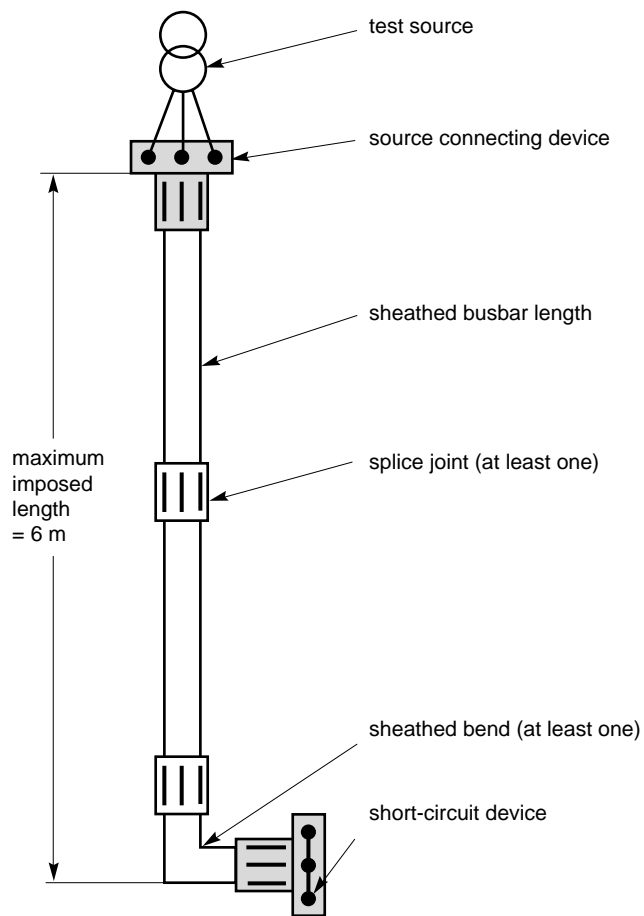

fig. 22: sketch showing a prefabricated busbar line such as defined by the standards for the type tests.

5. conclusion

The high electrodynamic forces occurring on a short-circuit and the material damage that they can cause justify the importance attached to mechanical withstand of busbars. An importance all the more vital as busbar withstand failure requires at the very least replacement of these busbars and thus shutdown of the installation.

It is thus advantageous for installers and/or users to choose equipment presenting a maximum guarantee (T.T.A.) or made up of modified standard elements, mounted in the factory and tested (P.T.T.A.).

In both cases, the importance of testing is obvious. However such tests call for considerable investment that only major

manufacturers can support in view of the necessary infrastructure and costs involved.

Design modifications from the type tested cases are, however, possible. It is in this respect, to a certain extent, that the calculation approach and the manufacturer's knowhow can take over from the experimental approach.

6. bibliography

Standards

- IEC 439-1: Low-voltage switchgear and controlgear assemblies. Type-tested and partially type-tested assemblies.
- IEC 439-2: Low-voltage switchgear and controlgear assemblies. Particular requirements for busbar trunking systems (busways). (NF C 63-411).
- IEC 865: Short-circuit currents-calculation of effects.
- IEC 909: Short-circuit current calculation in three-phase a.c. systems.
- IEC 909-1: Short-circuit current calculation in three-phase a.c. systems. Factors for the calculation of short-circuit currents in three-phase a.c. systems according to IEC 909.
- IEC 1117: Method for assessing the short-circuit withstand strength of partially type-tested assemblies (PTTA).

Merlin Gerin Cahiers Techniques

- Thermal study of LV electric switchboards
Cahier Technique n° 145
C. KILINDJIAN

- Operating dependability and LV electric switchboards
Cahier Technique n° 156 - O. BOUJU
- Calculation of short-circuit currents
Cahier Technique n° 158
R. CALVAS, B. DE METZ-NOBLAT, A. DUCLUZAUX, and G. THOMASSET

Various publications

- Elektodynamische Beanspruchung von parallelen Leitern, or
Electrodynamic effects on parallel lines
P. BALTENSPERGER
Bulletin Schweiz Elektotechn Verein n° 25, 1944
- Sectioned busbars in first and second category installations
R. ROLS.
Four-part paper published in the Revue de l'Aluminium n° 212 - 213 - 214 - 215, 1954
- Transmission of high currents in LV and MV ac current - 2nd part -
P. BEIGBEDER
Bulletin Etudes et Réalisations n° 43, 1957
- Calculation of three-phase busbar installations in view of withstand of electrodynamic forces
R. MASCARIN
Revue générale de l'Electricité RGE, August 1957.
- On the establishment of formulae designed to determine force per unit length in case of a short-circuit affecting a three-phase busbar in a ribbon arrangement.
R. MASCARIN.
Revue générale de l'Electricité RGE, March 1959.
- Über den Einfluß von Resonanzerscheinungen auf die mechanische Kurzschlußfestigkeit von biegesteifen Stromleitern.
P. SIEBER
AEG Mitteilungen n° 49, 1959
- Mechanical forces on current-carrying conductors.
E.D. CHARLES
Proceedings IEE, vol. 110, n° 9, September 1963
- Electrodynamic forces appearing in electric substations on a short-circuit
G. SCHAFFER
Revue Brown Boveri, 1970.